



BASS CRUNCH

Bass Guitar Preamp

User's manual

www.amtelectronics.com

Safety precautions

CAUTION! There are no user serviceable parts inside. Repair of the device can be carried out only by qualified experts. If the device is not used it must be disconnected from mains.

WARNING! In order to avoid fire or electric shock the device must not be exposed to rain or moisture. Do not let water or other liquid get inside the device. Do not place vessels such as vases filled with liquid on top of the device.

 This symbol indicates important information related to the device maintenance and servicing contained in the accompanying documentation.

Please read the instruction manual very carefully.

1. Keep the user's guide at hand.
2. Pay attention to warnings.
3. Follow all instructions related to device operation.
4. To clean the device, use only a dry cloth having disconnected the device from mains prior to that.
5. Do not place the device near heat sources, keep it from direct sunlight.
6. Lay the mains cable so that it is not stepped on and avoid its contact with sharp corners, etc. If you use the plug or outlet for switching the device off they should be easily accessible.
7. Use only additional devices and accessories recommended by the manufacturer.
8. Disconnect the device from mains in case of thunder-storm or when the device is not in use for prolonged time.
9. Remove the battery, if you don't use the device for a prolonged period of time.
10. All works related to the device repair must be done only by qualified service personnel.
11. **WARNING!** All service instructions are intended only for qualified personnel in order to avoid electric shock; do not carry out any repair works which are not described in the instruction manual. Repair works must be carried out only by qualified experts.

Contents

Important instructions	1
Complete set	1
Introduction	2
BC-1 Channels Description	2
Before you start	2
Specifications	2
Power adapter low-voltage connector contacts arrangement	2
Powering the device from battery and power adapter	2
Controls	3
Front panel	3
Left panel	3
Right panel	3
Batteries installation	3
FX.LOOP mode switch	4
Audio connections and switching	4
Block diagram	4

IMPORTANT INSTRUCTIONS!

NON-OBSERVANCE OF THE FOLOWING INSTRUCTIONS MIGHT RESULT IN YOUR DEVICE DAMAGE. GUARANTEE IS VOID IF THE DAMAGES ARE CAUSED BY NON-OBSERVANCE OF THESE INSTRUCTIONS.

- After transportation or storage of the device under negative temperatures make sure to leave the device under room temperature in its original packaging for AT LEAST 2 HOURS!
- To connect the bass guitar preamp to other devices use exclusively cables intended for such connections.
- Under no circumstances use other types of cables such as for speakers etc.

CONNECTION of the bass guitar preamp to power adapter:

- Connect the adapter only AFTER all audio connections have been accomplished!
- Before connecting the preamp to power adapter make sure that the casing, cables, low-voltage connector and power plug are free from damages: no cuts, cracks, dents and so on and are in operable condition.
- To connect the preamp to the power adapter first insert the low-voltage connector of power adapter into corresponding socket on the rear panel of the preamp and then plug the adapter into the wall outlet.

DISCONNECTION of the bass guitar preamp from power adapter:

- To disconnect the preamp from the power adapter first disconnect the adapter from mains and then disconnect its low-voltage connector from the socket on the rear panel of the preamp.

COMPLETE SET

1. AMT BC-1	1
2. Instruction manual	1
3. Packaging box	1
4. Warranty card	1

INTRODUCTION

BC-1 Bass Crunch floor Bass Guitar preamp is intended for use both in studio and live on stage.

Working at BC-1 the AMT Electronics experts developed new original circuitry solutions using JFET-based tube stages emulation resulting in clean, overdriven or mixed quality sound with minimum power consumption.

Flexible sound adjustments and wide variety of switching possibilities will allow you to obtain your sought-after sound practically anywhere. Thanks to the device compactness and lightness you can carry it in a gig bag side pocket or a bag.

Bass crunch BC-1 preamp is based on a two-channel circuit.

CLEAN channel shapes the classic bass guitar sound characteristic for «old» amplifiers and allows both velvet transparent sound and slight compressed overdrive depending on the position of Gain control.

DRIVE channel contains a number of over amplification stages and is intended for obtaining the modern sound from clean to totally overdriven one. The High Mode provides additional possibilities in terms of the range enrichment towards higher sound density and aggressiveness. The adjustable 3-position mid-range filter combined with deep adjustments along the frequency ranges offer a musician its rich possibilities related to shaping of the overdriven tone range.

 CAUTION! AMT preamps like any other high-class devices are very sensitive to power adaptor quality. We insist on your using either two 9V 6F22 batteries or an adapter meeting the quality specifications to power your device.

Before you start

For safe transportation the device was carefully packaged by the manufacturer. However, if the cardboard packaging is damaged you should immediately inspect the device for the absence of external damages.

- In case of damages do NOT SEND the device to manufacturer, but inform the seller or transport agency, since otherwise you will lose the right to damage compensation.
- In order to avoid damages during storage and transportation always use original packing.
- Do not allow children to play with the device and packaging materials.
- Please, recycle all packing materials in the way harmless to the environment.
- In order to avoid the device overheating provide a sufficient airflow around it; do not cover it and do not place near other heat emitting devices.
- Device operation near powerful radio transmitters and sources of high-frequency signals can result in appreciable deterioration of sound. In this case increase the distance between the device and the transmitter and use screened cables for all interconnections.

CAUTION!

Please be aware that high volume can harm your hearing and / or damage the dynamic heads of your acoustic system. Before turning the device on rotate Volume controls to extreme left position (counter-clockwise). At all times try to adhere to moderate volume level.

SPECIFICATIONS

INPUT	
Input resistance	1,0 MOhm
Response	-10dB (250mV)
OUTPUT	
Output resistance	600 Ohm
Output signal level	0dB (775mV)
Recommended load, min	10 kOhm
CAB.SIM. output	
Output resistance	600 Ohm
Output signal level	0dB (775mV)
Рекомендуемая мин. нагрузка	10 kOhm
DI OUT	
Output resistance	600 Ohm
Output signal level	0dB (775mV)
Recommended load, min	10 kOhm
RETURN	
Input resistance	1,0 MOhm
Response	-10dB (250mV)
SEND	
Output resistance	600 Ohm
Output signal level	-10dB (250mV)
Recommended load, min	10 kOhm
Power	Two 6F22 batteries
Voltage	DC 18V
Consumed current	12,5 mA max
Power adapter (optional)	
Voltage	DC 18V
Load current	0,3 A min
Dimensions / Weight	
NET dimensions (WxHxD). (Without power adapter)	127x59x106 mm
NET weight (without batteries and power adaptor)	0,47 kg
GROSS dimensions (WxHxD).	About 206x83x140mm
GROSS weight	About 0,6 kg



Use only auxiliary devices and accessories recommended by the manufacturer.

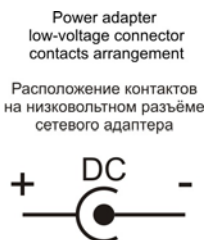

Powering the device from battery and power adapter

AMT BC-1 is powered either by two 9V 6F22 internal batteries or external DC 18V power adaptor (the required adaptor quality specifications are shown in Specifications section)

When using batteries the device enters ON mode only after insertion of mono jack into the device's INPUT.

When using DC 18V adaptor, the device is switched on after insertion of the adaptor's connector into the device - insertion of mono jack is not necessary.

CONTROLS
Front panel

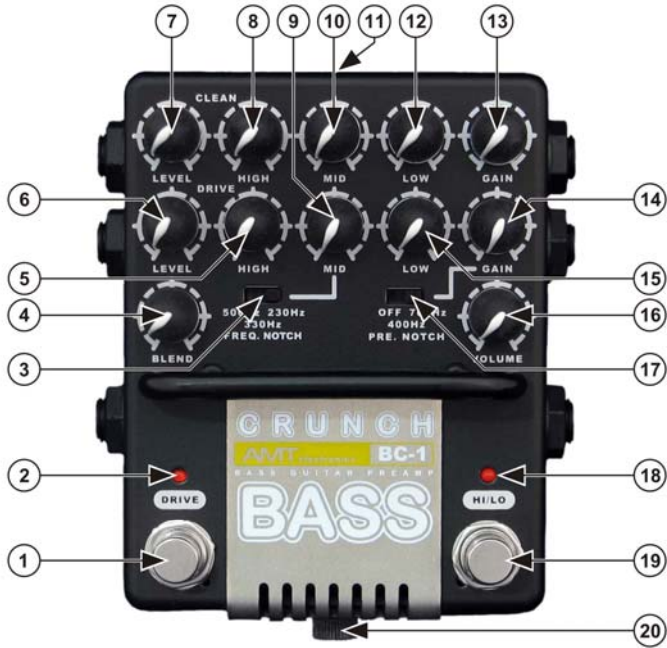

1. CLEAN / DRIVE footswitch for selecting CLEAN or DRIVE;
2. DRIVE channel operation indicator;
3. FREQ. NOTCH – cutout frequencies switch (rejecter filter) 500Hz, 330Hz, 230Hz (see graph 1);
4. BLEND – signal level balance adjustment between channels CLEAN and DRIVE;
5. HIGH – adjusts high frequency range of DRIVE channel;
6. LEVEL – adjusts signal volume level of DRIVE channel;
7. LEVEL – adjusts signal volume level of CLEAN channel;
8. HIGH – adjusts high frequency range of CLEAN channel;
9. MID – adjusts middle frequency range of DRIVE channel;
10. MID – adjusts middle frequency range of CLEAN channel;
11. DC-18V (located on rear panel) for connection of power adaptor;
12. LOW – adjusts low frequency range of CLEAN channel;
13. GAIN – adjusts sensitivity level of CLEAN channel;
14. GAIN – adjusts sensitivity level of DRIVE;
15. LOW – adjusts low frequency range of DRIVE channel;
16. MASTER VOLUME – BC-1's overall output level adjustment;
17. PRE.NOTCH – rejecter filter switch before Drive stage. 700Hz, 400Hz (see graph 2);
18. DRIVE channel operation indicator in HIGH mode;
19. Footswitch HI/LO – Drive channel increased sensitivity on/off;
20. Battery compartment screw.

Left panel



21. OUTPUT – direct output to power amp;
22. CTRL OUT – AMT TS-2MIDI aux converters control output;
23. CAB.SIM. – direct output to mixer's line input;
24. DI OUT – balanced output intended for connection of devices equipped with balanced inputs.

Right panel



25. INPUT – instrument input of the preamp;
26. RETURN – aux effect signal return (-10dB);
27. SEND – signal send to aux effect (-10dB).

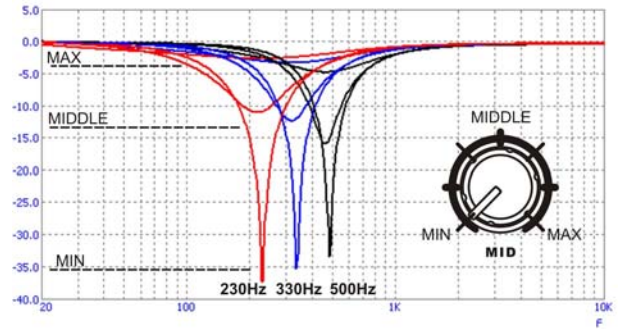

Graph 1 – FREQ.NOTCH switch specification

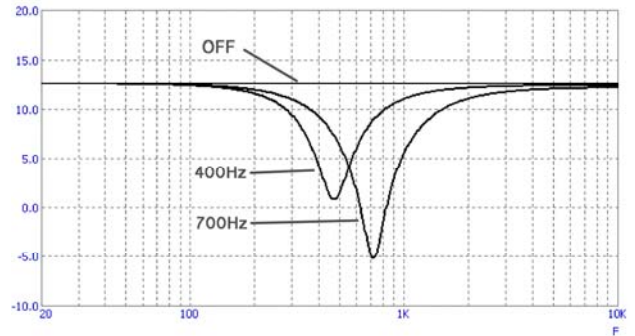

Graph 2 – PRE.NOTCH switch specification



WARNING! All cable connections must be made ONLY WITH PREAMP SWITCHED OFF!

BATTERY REPLACEMENT



WARNING! AMT BC-1 requires two 9V 6F22 batteries. Never use old and new batteries simultaneously. Replace both batteries if necessary. Do not mix batteries from different manufacturers

To use (replace) the batteries:

1. Loosen the screw (20), lift the battery compartment cover to access the batteries;
2. Carefully picking one battery with your finger lift it from thy compartment and pull it toward yourself;
3. Repeat 2 for the second battery;
4. Insert new batteries using the reverse sequence with correct polarity (battery «+» upwards);
5. Tightly close the battery compartment cover. Tighten the screw (20) slightly pressing the cover..

Note in order not to lose the screw (20) do not remove it from the cover, just use it to loosen the cover.

FX.LOOP MODE SWITCH

WARNING! FX.LOOP mode is to be selected with disconnected power supply and all other cables of the guitar preamp. **DO NOT USE** the device without the back cover. **DO NOT TOUCH** the circuit board and other components behind the cover with your hands or objects.

To switch between FX.LOOP modes (parallel/serial):

Remove the bottom cover of the device by slightly loosening 4 (four) fastening screws using cross-point screwdriver.

Carefully move the mini switch to the required operation mode. The PCB shows the following markings: P – parallel and S -serial.

Replace the cover and fix it in place by means of four fastening screws.

Note: some of the earlier modifications do not have FX.LOOP switch.

AUDIO CONNECTIONS AND SWITCHING

WARNING! All cable connections must be made **ONLY WITH** PREAMP SWITCHED OFF!

Possible audio connections of the preamp with external devices:

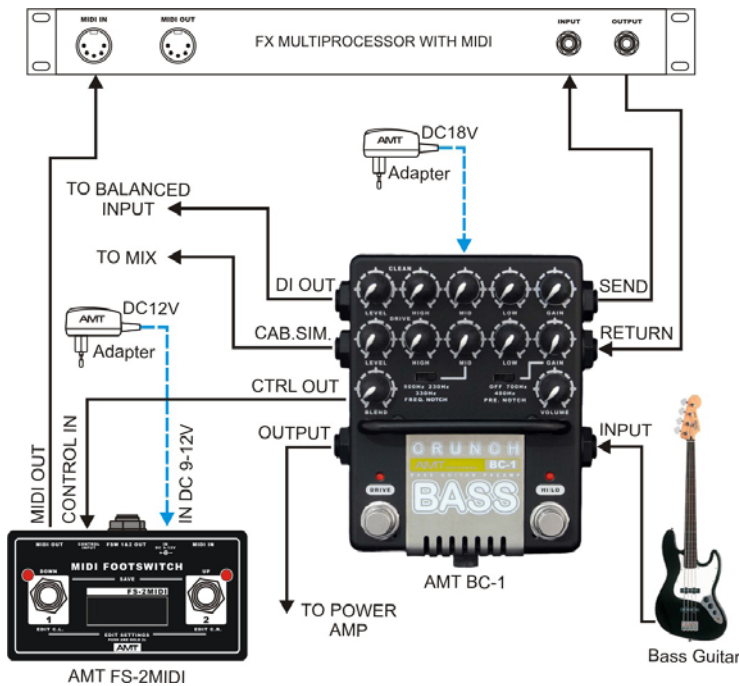

AMT BC-1 Block diagram
AMT BC-1 Блок-схема

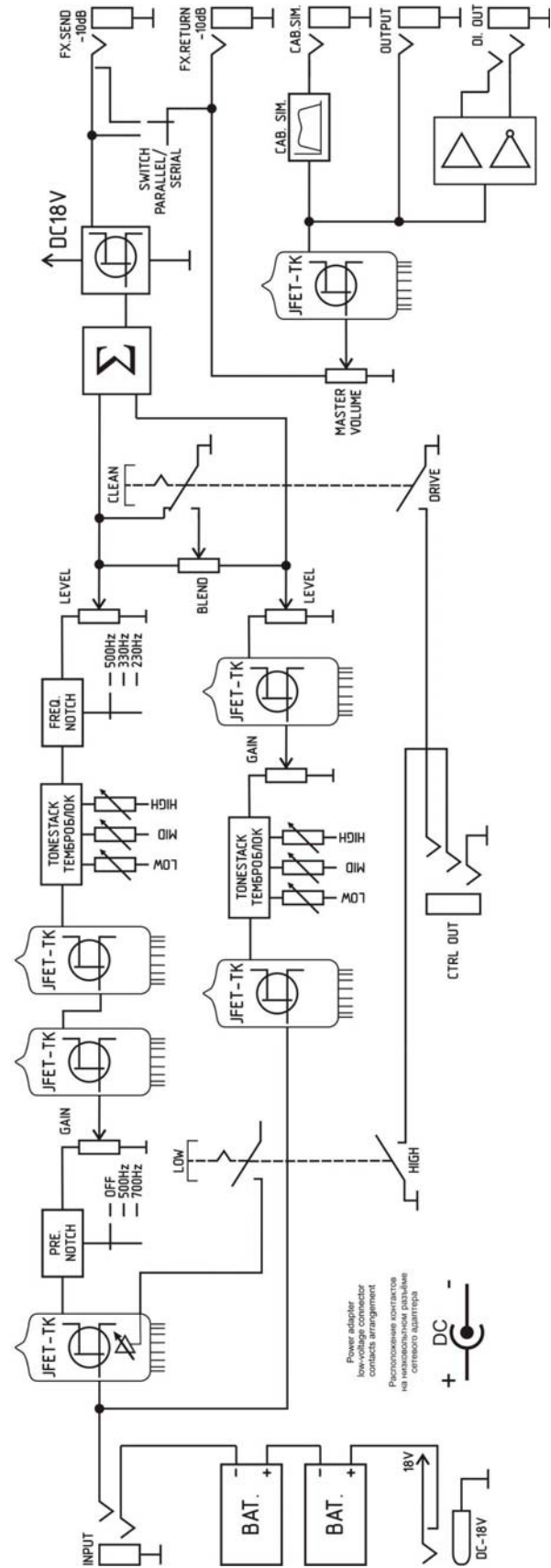

Power adapter low-voltage connector contacts arrangement
Расположение контактов на низковольтной разъемной контактной панели адаптера

AMT Electronics reserves the right to change the internal and external design of the device which won't decrease its consumer properties without preliminary notification. In this connection the specifications and appearance of the device might differ from the ones shown in this document